

Please note, illustrations and specifications are not binding in detail. The bath model supplied may vary.



Made in UK

Quality Acrylic Baths

Manufactured in the UK

Amare Bath

Installation Instructions

- Read through the instruction booklet first before commencing any work. If you are unsure of any aspect of the installation, we recommend you contact a reputable tradesperson.

- Prior to fitting your bath, carefully remove all the packaging and film from the bath and examine the bath for damage and suitability of colour match.

- Any refixing costs or claims for wrong colour match and/or any other fault will not be accepted after fixing.

No claims for the above will be accepted once the bath is fitted.

WARNING - This product contains magnets within the waste cover.

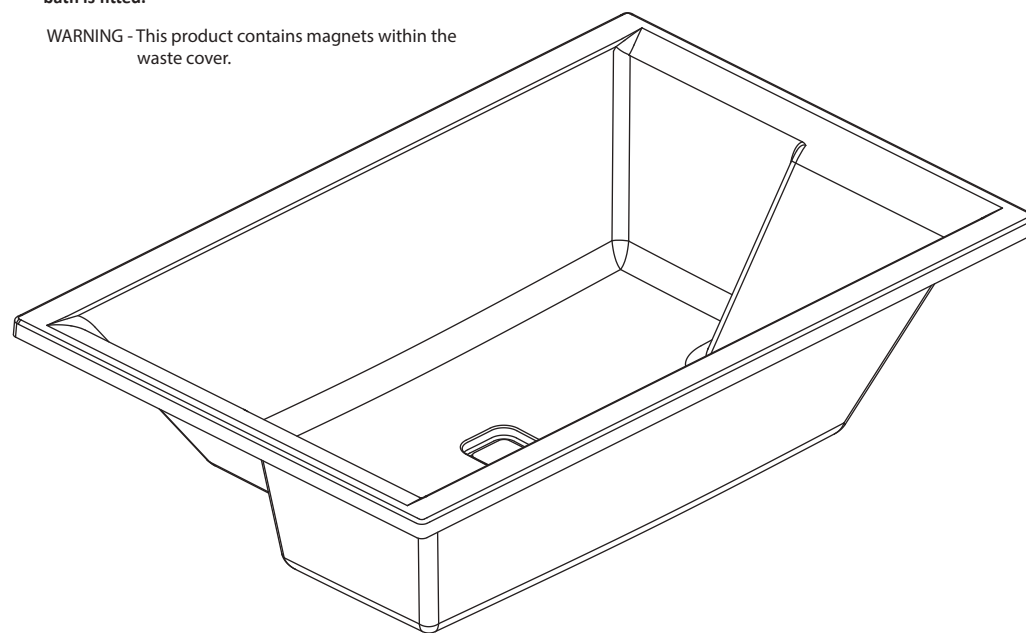

Please note, the bath shown is for illustration purposes only.

25
Year
Guarantee

V1/090418
1028

Amare Bath

Installation Instructions

Before you start

- Before fixing remove ALL protective covering and examine carefully. The polythene film must be removed in full and the bath checked for any visible damage.
- Unpack and check the product is complete and undamaged.
- Have the correct tools available.
- Please notify the retailer immediately of any damage or faults. The manufacturer cannot be held responsible for any installation costs that may arise from damaged or faulty product being installed. The guarantee does not cover impact related damage. Please dispose of all packaging with due regard to the environment.

Safety

- Handle the bath with care.
- This product is heavy and requires two persons to carry.
- When drilling walls, check first for hidden pipes and cables.
- Use safety eyewear when drilling.
- Keep small parts away from children.

Tools required

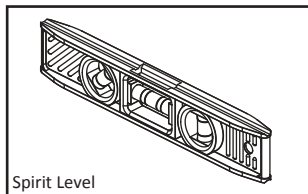

Spirit Level

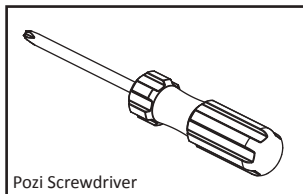

Pozi Screwdriver

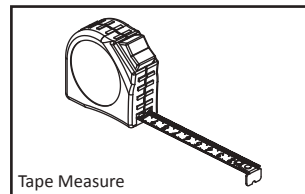

Tape Measure

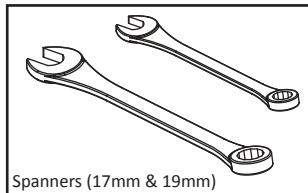

Spanners (17mm & 19mm)

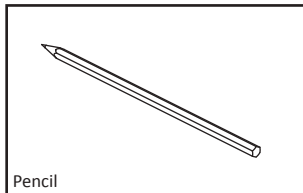

Pencil

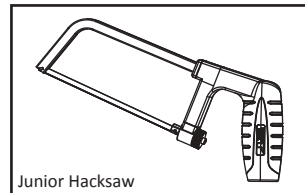

Junior Hacksaw

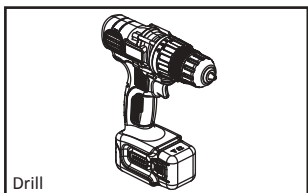

Drill

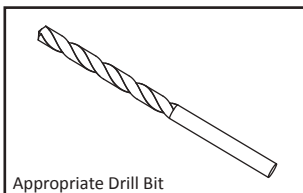

Appropriate Drill Bit

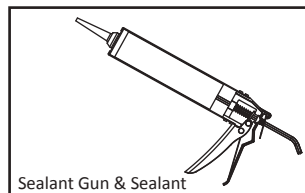

Sealant Gun & Sealant

*Tools shown not supplied

*Ensure drill bit used is suitable for wall surface!

Parts provided

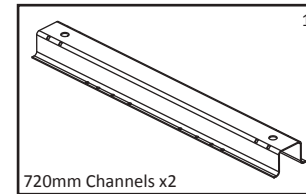

720mm Channels x2

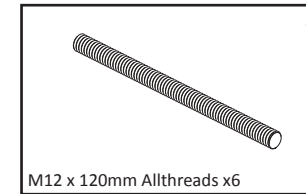

M12 x 120mm Allthreads x6



16mm Self Tapping Screws x24

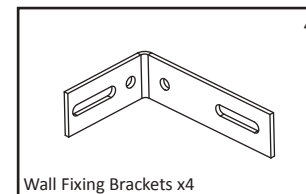

Wall Fixing Brackets x4

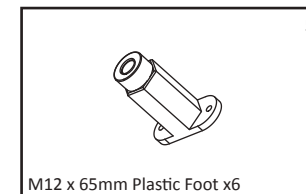

M12 x 65mm Plastic Foot x6

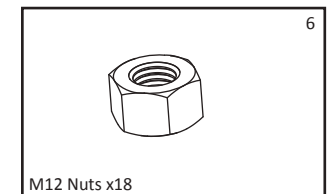

M12 Nuts x18

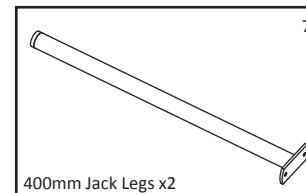

400mm Jack Legs x2

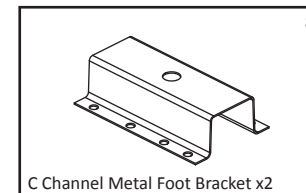

C Channel Metal Foot Bracket x2

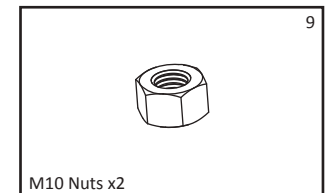

M10 Nuts x2

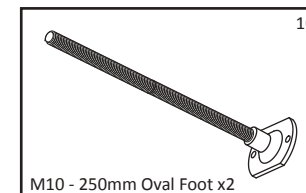

M10 - 250mm Oval Foot x2

- We have taken great care to ensure that this product reaches you in perfect condition. However should any parts be damaged or missing please contact your point of purchase. This does not affect your statutory rights. In addition if you require replacement parts your point of purchase will be happy to assist.